

# EXPORT TOOLS



## Listino PREZZI OTTOBRE 2017

Il catalogo EXport Tools III -14 e gli aggiornamenti (Depliant Verde e Depliant Blu) restano validi per la parte tecnica: caratteristiche e utilizzo degli utensili, riferimento ai ricambi e agli inserti.

I Prezzi di listino sostituiscono e annullano quelli del Catalogo III-14

Lo sconto a voi riservato è il solito

## INDICE

ERRATA CORRIGE	3
NUOVI PREZZI	4-29
RICAMBI	30
INSERTI	31-32
DATI EXPORT TOOLS S.R.L.	32



# ERRATA CORRIGE

## DEPLIANT VERDE

F500CC32100 D=50 non 32

## DEPLIANT BLU

IZSPUC31 Inserti spessore 3106 e non 3109

FRESA F500CC6020D Z2 invece di Z1

PINS1317560 L1=50 non 60

## CATALOGO III - 14

### PAG Descrizione

4	K08KSTFFR07	VITE V23 non B22
4	K08KSTFFL07	VITE V23 non B22
5	K08KEXFPR04	VITE V24 non B20
5	K08KEXFPL04	VITE V24 non B20
7	E25PCLNR12	e non PLCNR12
7	E32PCLNR12	e non PLCNR12
7	E25PCLNL12	e non PLCNR12
7	E32PCLNL12	e non PLCNR12
8	E10SCLCR06	L=125
8	E12SCLCR06	L=150
8	E25SCLCR09	L=300
8	E32SCLCR09	L=300
8	E10SCLCL06	L=125
8	E12SCLCL06	L=150
8	E25SCLCL09	L=300
8	E32SCLCR09	L=300
8	E10STFCR11	V28 - no V22 L=125
8	E12STFCR11	L=150
8	E25STFCR16	L=300
8	E32STFCR16	L=300
8	E10STFCL11	V28 - no V22 L=125
8	E12STFCL11	L=150
8	E25STFCL16	L=300
8	E32STFCL16	L=300
9	E10SDUCR07	L=125
9	E12SDUCR07	L=150
9	E25SDUCR11	L=300
9	E25SDUCR11	L=300
9	E10SDUCL07	L=125
9	E12SDUCL07	L=150
9	E25SDUCL11	L=300
9	E32SDUCL11	L=300
9	E10SDQCR07	L=125
9	E12SDQCR07	L=150

9	E10SDQCL07	L=125
9	E12SDQCL07	L=150
10	E06SEXPR04	V24 no B20
10	E06SEXPL04	V24 no B20
11	UEV40400	invece di UEV40100
11	UEV60780	D=60 invece che 63
13	Testine TH...PDNUR	Ins. DNMG1506 no DNMG1504
13	Testine TH...PDNUL	Ins. DNMG1506 no DNMG1504
25	F100CC03025	Z3 non Z2
30	Inserti concavi e convessi spostati a pag.31	
31	IZAPLR22A900 non	IZSPUR22A900
31	IZAPLR22AB100 non	IZSPUR22AB100
31	IZAPLR22AT90 non	IZSPUR22AT900
31	IZAPLR22ABT10 non	IZSPUR22ABT10
33	VTX3505 non	non V3502
33	VTX3504	non V3503
33	VTX405	non V3603
33	VTX408	non V3705
34	FRESE700M	non più costruite
40	PINS3WC0670	d=50 non 40
40	PINS3WC0890	d=60 non 50
40	PINS3WC0895	d=60 non 50
41	PINS4WC0318	d=20 non 25
41	PINS4WC0319	d=20 non 25
41	PINS4WC0320	d=20 non 25
44	AIBARL3540	d=32 non 25
48	UER25MRCMT0880	05 invece che S1
48	UER25MRCMT1080	V4C non V4R - 05 non S1
48	UCR32MRCMT12100	V4C non V4R - 05 non S1
48	UCR32MRCMT12L100	V4C non V4R - 05 non S1
48	UEL25MRCMT0880	05 non S1
48	UEL25MRCMT1080	V4C non V4R - 05 non S1
48	UEL32MRCMT12100	V4C non V4R - 05 non S1
48	UEL32MRCMT12L100	V4C non V4R - 05 non S1
52	SVJCR10M11	VCMT1103 non VCMT11T3
52	SVJCR12M11	VCMT1103 non VCMT11T3
52	SVJCR16M11	VCMT1103 non VCMT11T3
52	SVJCL10M11	VCMT1103 non VCMT11T3
52	SVJCL12M11	VCMT1103 non VCMT11T3
52	SVJCL16M11	VCMT1103 non VCMT11T3
66	S32UCSKPR/L12	L1 non L0
66	S40VCSKPR/L12	L1 non L0
66	S32UCTFPR/L16	L1 non L0
66	S40VCTFPR/L16	L1 non L0
87	Morse snodabili non più costruite	

## DCMT

PAGINA 3 CATALOGO

K=93°

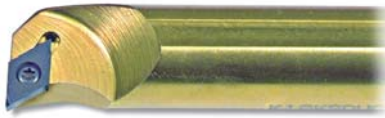

DESTRA	€	SINISTRA	€
K10KSDUCR07	230,00	K10KSDUCL07	230,00
K12KSDUCR07	240,00	K12KSDUCL07	240,00
K16KSDUCR07	420,00	K16KSDUCL07	420,00
K20KSDUCR11	780,00	K20KSDUCL11	780,00
K25KSDUCR11	1.050,00	K25KSDUCL11	1.050,00
K32KSDUCR11	1.750,00	K32KSDUCL11	1.750,00

## CCMT

PAGINA 4 CATALOGO

K=95°



DESTRA	€	SINISTRA	€
K08KSCLCR06	200,00	K08KSCLCL06	200,00
K10KSCLCR06	230,00	K10KSCLCL06	230,00
K12KSCLCR06	240,00	K12KSCLCL06	240,00
K16KSCLCR09	420,00	K16KSCLCL09	420,00
K20KSCLCR09	780,00	K20KSCLCL09	780,00
K25KSCLCR09	1.050,00	K25KSCLCL09	1.050,00
K32KSCLCR09	1.750,00	K32KSCLCL09	1.750,00

## TCMT

PAGINA 4 CATALOGO

K=91°



DESTRA	€	SINISTRA	€
K08KSTFPR07	200,00	K08KSTFPL07	200,00
K10KSTFCR11	230,00	K10KSTFCL11	230,00
K12KSTFCR11	230,00	K12KSTFCL11	230,00
K16KSTFCR11	420,00	K16KSTFCL11	420,00
K20KSTFCR16	780,00	K20KSTFCL16	780,00
K25KSTFCR16	1.050,00	K25KSTFCL16	1.050,00
K32KSTFCR16	1.750,00	K32KSTFCL16	1.750,00

## EPGT

PAGINA 5 CATALOGO

K=100°



DESTRA	€	SINISTRA	€
K08KEXPR04	210,00	K08KEXPL04	210,00

## SET BARENI antivibranti in tungsteno

DEPLIANT ROSSO



KITKSCLCR06 Destro	CCMT06
K08KSCLCR06 + K10KSCLCR06 + K12KSCLCR06	€ 600,00
KITKSCLCR06 Sinistro	CCMT06
K08KSCLCL06 + K10KSCLCL06 + K12KSCLCL06	€ 600,00

## PROLUNGHE ANTIVIBRANTI IN TUNGSTENO

PAGINA 5 CATALOGO

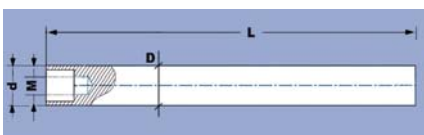

	€
KABAR16160	570,00
KABAR20200	930,00
KABAR25250	1.200,00
KABAR32320	1.900,00

## BARRE ANTIVIBRANTI in tungsteno grezze

PAGINA 5 CATALOGO

PREZZI A RICHIESTA

# CCMT

PAGINA 8 CATALOGO

K=95°

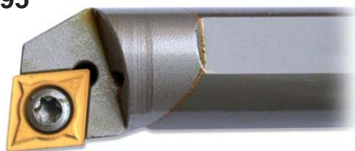

DESTRA	€	SINISTRA	€
E08SCLCR06	180,00	E08SCLCL06	180,00
E10SCLCR06	190,00	E10SCLCL06	190,00
E12SCLCR06	215,00	E12SCLCL06	215,00
E16SCLCR09	360,00	E16SCLCL09	360,00
E20SCLCR09	620,00	E20SCLCL09	620,00
E25SCLCR09	880,00	E25SCLCL09	880,00
E32SCLCR09	1.660,00	E32SCLCL09	1.660,00

# TCMT

PAGINA 8 CATALOGO

K=91°



DESTRA	€	SINISTRA	€
E10STFCR11	190,00	E10STFCL11	190,00
E12STFCR11	215,00	E12STFCL11	215,00
E16STFCR11	360,00	E16STFCL11	360,00
E20STFCR16	620,00	E20STFCL16	620,00
E25STFCR16	880,00	E25STFCL16	880,00
E32STFCR16	1,660,00	E32STFCL16	1,660,00

# DCMT

PAGINA 9 CATALOGO

K=93°



DESTRA	€	SINISTRA	€
E08SDUCR07	220,00	E08SDUCL07	220,00
E10SDUCR07	190,00	E10SDUCL07	190,00
E12SDUCR07	215,00	E12SDUCL07	215,00
E16SDUCR07	360,00	E16SDUCL07	360,00
E20SDUCR11	620,00	E20SDUCL11	620,00
E25SDUCR11	880,00	E25SDUCL11	880,00
E32SDUCR11	1.660,00	E32SDUCL11	1.660,00

# DCMT

PAGINA 9 CATALOGO

K=107°, 30'



DESTRA	€	SINISTRA	€
E10SDQCR07	190,00	E10SDQCL07	190,00
E12SDQCR07	215,00	E12SDQCL07	215,00
E16SDQCR07	360,00	E16SDQCL07	360,00
E20SDQCR11	620,00	E20SDQCL11	620,00

# EPGT

PAGINA 10 CATALOGO

K=100°



DESTRA	€	SINISTRA	€
E06SEXPRO4A	220,00	E06SEXPLO4A	220,00

SET BARENI antivibranti in metallo duro con testina saldobrasata in acciaio DEPLIANT ROSSO



KITESCLCR06 Destro  
E08SCLCR06 + E10SCLCR06 + E12SCLCR06 € 340,00

KITESCLCL06 Sinistro  
E08SCLCL06 + E10SCLCL06 + E12SCLCL06 € 340,00

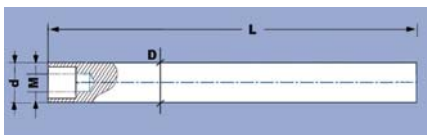

	€
EBAR16160	530,00
EBAR20200	730,00
EBAR25250	980,00

## BARRA UEV

PAGINA 11 CATALOGO

7X	€	10X	€
UEV25250	2.120,00	UEV25325	4.060,00
UEV32320	2.430,00	UEV32416	4.420,00
UEV40400	2.800,00	UEV40520	4.560,00
UEV444518	3.250,00	UEV444584	4.800,00
UEV50500	3.450,00	UEV50650	5.060,00
UEV60600	4.680,00	UEV60780	6.800,00
UEV7620787	5.600,00	UEV762D1016	10.000,00
		UEV101601270	17.600,00

## TESTINA PER INSERTI CCMT con passaggio di refrigerante

PAGINA 12 CATALOGO

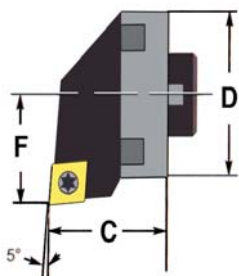

DESTRA	€	SINISTRA	€
TH16SCLCR09	430,00	TH16SCLCL09	430,00
TH20SCLCR09	450,00	TH20SCLCL09	450,00
TH24SCLCR09	480,00	TH24SCLCL09	480,00
TH28SCLCR09	510,00	TH28SCLCL09	510,00
TH32SCLCR12	560,00	TH32SCLCL12	560,00
TH40SCLCR12	610,00	TH40SCLCL12	610,00

## TESTINA PER INSERTI DCMT con passaggio di refrigerante

PAGINA 12 CATALOGO

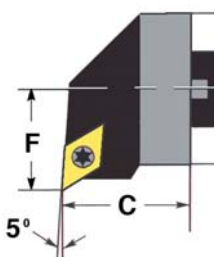

DESTRA	€	SINISTRA	€
TH16SDUCR11	430,00	TH16SDUCL11	430,00
TH20SDUCR11	450,00	TH20SDUCL11	450,00
TH24SDUCR11	480,00	TH24SDUCL11	480,00
TH28SDUCR11	510,00	TH28SDUCL11	510,00
TH32SDUCR11	560,00	TH32SDUCL11	560,00
TH40SDUCR11	610,00	TH40SDUCL11	610,00

## TESTINA PER INSERTI TCMT con passaggio lubrificante

PAGINA 12 CATALOGO

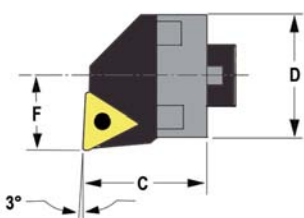

DESTRA	€	SINISTRA	€
TH16STUCR11	430,00	TH16STUCL11	430,00
TH20STUCR16	450,00	TH20STUCL16	450,00
TH24STUCR16	480,00	TH24STUCL16	480,00
TH28STUCR16	510,00	TH28STUCL16	510,00
TH32STUCR16	560,00	TH32STUCL16	560,00
TH40STUCR16	610,00	TH40STUCL16	610,00

## TESTINA PER INSERTI CNMG con passaggio refrigerante

PAGINA 13 CATALOGO

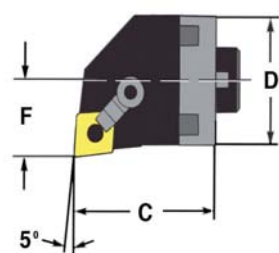

DESTRA	€	SINISTRA	€
TH16PCLNR12	430,00	TH16PCLNL12	430,00
TH20PCLNR12	450,00	TH20PCLNL12	450,00
TH24PCLNR12	480,00	TH24PCLNL12	480,00
TH28PCLNR12	510,00	TH28PCLNL12	510,00
TH32PCLNR12	560,00	TH32PCLNL12	560,00
TH40PCLNR12	610,00	TH40PCLNL12	610,00

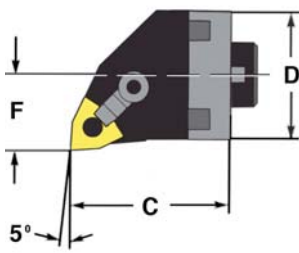

DESTRA	€	SINISTRA	€
TH16MWLNR08	430,00	TH16MWLNL08	430,00
TH20MWLNR08	450,00	TH20MWLNL08	450,00
TH24MWLNR08	480,00	TH24MWLNL08	480,00
TH28MWLNR08	510,00	TH28MWLNL08	510,00
TH32MWLNR08	560,00	TH32MWLNL08	560,00
TH40MWLNR08	610,00	TH40MWLNL08	610,00

TESTINA PER INSERTI DNMG con passaggio di lubrificante

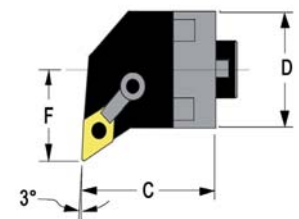

DESTRA	€	SINISTRA	€
TH16PDUNR15	430,00	TH16PDUNL15	430,00
TH20PDUNR15	450,00	TH20PDUNL15	450,00
TH24PDUNR15	480,00	TH24PDUNL15	480,00
TH28PDUNR15	510,00	TH28PDUNL15	510,00
TH32PDUNR15	560,00	TH32PDUNL15	560,00
TH40PDUNR15	610,00	TH40PDUNL15	610,00

MANICOTTI DI RIDUZIONE



	€		€		€
MN2508T	170,00	MN3208T	180,00	MN4008T	198,00
MN2510T	170,00	MN3210T	180,00	MN4010T	198,00
MN2512T	170,00	MN3212T	180,00	MN4012T	198,00
MN2516T	170,00	MN3216T	180,00	MN4016T	198,00
MN2520T	170,00	MN3220T	180,00	MN4020T	198,00
		MN3225T	180,00	MN4025T	198,00
				MN4032T	198,00

BARRE PORTATESTINE IN ACCIAIO



	€
B02522011	230,00
B03225011	250,00
B04031511	330,00
B05040011	380,00
B06050011	380,00
B08063011	530,00

BARRE IN ACCIAIO Portatestine a coda di rondine con attacco VDI

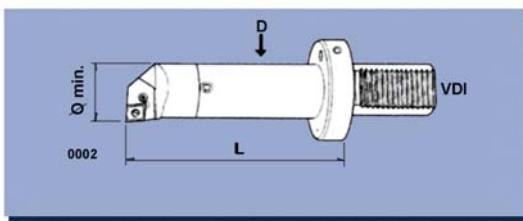

	€
BVDI4032200	1.200,00
BVDI4040250	1.250,00
BVDI4050300	1.300,00
BVDI4063300	1.350,00
BVDI5040250	1.350,00
BVDI5050300	1.400,00
BVDI5063350	1.450,00
BVDI5080350	1.500,00

TESTINE A CODA DI RONDINE CCMT



K=93°

DESTRA	€	SINISTRA	€
TCCM02509R	310,00	TCCM02509L	310,00
TCCM03209R	350,00	TCCM03209L	350,00
TCCM04009R	390,00	TCCM04009L	390,00
TCCM05009R	420,00	TCCM05009L	420,00
TCCM06312R	480,00	TCCM06312L	480,00

## TESTINE A CODA DI RONDINE TCMT

PAGINA 17 CATALOGO



K=91°

DESTRA	€	SINISTRA	€
TTCM02511R	290,00	TTCM02511L	290,00
TTCM03216R	330,00	TTCM03216L	330,00
TTCM04016R	370,00	TTCM04016L	370,00
TTCM05016R	390,00	TTCM05016L	390,00
TTCM06316R	450,00	TTCM06316L	450,00

## TESTINE A CODA DI RONDINE CNMG

PAGINA 18 CATALOGO



K=95°

DESTRA	€	SINISTRA	€
TCNM03212R	330,00	TCNM03212L	330,00
TCNM04012R	370,00	TCNM04012L	370,00
TCNM05012R	390,00	TCNM05012L	390,00
TCNM06312R	450,00	TCNM06312L	450,00
TCNM08019R	680,00	TCNM08019L	680,00
TCNM10019R	820,00	TCNM10019L	820,00

## TESTINE A CODA DI RONDINE TNMG

PAGINA 18 CATALOGO



K=91°

DESTRA	€	SINISTRA	€
TTNM03216R	330,00	TTNM03216L	330,00
TTNM04016R	370,00	TTNM04016L	370,00
TTNM05016R	390,00	TTNM05016L	390,00
TTNM06316R	450,00	TTNM06316L	450,00
TTNM08022R	680,00	TTNM08022L	680,00
TTNM10022R	820,00	TTNM10022L	820,00

## TESTINE A CODA di rondine DNMG

CATALOGO BLU

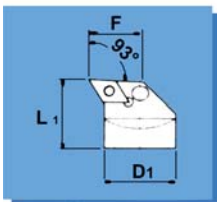

DESTRA	€	SINISTRA	€
TDNM05015R	450,00	TDNM05015L	450,00
TDNM06315R	500,00	TDNM06315L	500,00
TDNM08015R	580,00	TDNM08015L	580,00

## TESTINE A CODA di rondine KNUX

CATALOGO BLU

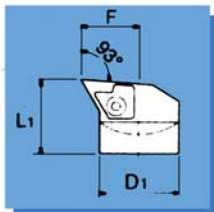

DESTRA	€	SINISTRA	€
TKNM03216R	330,00	TKNM03216L	330,00
TKNM04016R	370,00	TKNM04016L	370,00
TKNM05016R	390,00	TKNM05016L	390,00
TKNM06316R	460,00	TKNM06316L	460,00
TKNM08016R	680,00	TKNM08016L	680,00

## TESTINE a CODA di rondine grezze

CATALOGO VERDE



d	€
32	280,00
40	330,00
50	360,00
63	400,00
80	420,00
100	570,00



## Per smusso a 30°

PAGINA 21 CATALOGO



F30030034

€  
120,00

## Per smusso a 60°

PAGINA 21 CATALOGO



F30060015  
F30060025  
F30060034  
F30060SET

€  
75,00  
85,00  
120,00  
250,00

## Per smusso a 90°

PAGINA 22 CATALOGO



F30090016  
F30090021  
F30090032  
F30090050  
F30090SET

€  
60,00  
65,00  
105,00  
140,00  
200,00

## Per smusso a 120°

PAGINA 22 CATALOGO



F300120034

€  
120,00

## Per smusso a svasature a 90°

PAGINA 22 CATALOGO



F30090X023  
F30090X028  
F30090X042  
F30090X023L  
F30090X028L  
F30090X042L

€  
85,00  
100,00  
130,00  
95,00  
115,00  
140,00

## Per smussi registrabili

PAGINA 23 CATALOGO



F300REG20  
F300REG25  
F300REGSET

€  
190,00  
190,00  
340,00

Per spallamento 90° stelo cilindrico APKT 1003 senza fori

PAGINA 24 CATALOGO



	€	€	SERIE LUNGA	€	
F100CI010	75,00	F100CI019	90,00	F100CIL010120	80,00
F100CI011	75,00	F100CI020	120,00	F100CIL012120	80,00
F100CI012	75,00	F100CI021	120,00	F100CIL014120	90,00
F100CI013	75,00	F100CI022	120,00	F100CIL016200	120,00
F100CI014	75,00	F100CI025	130,00	F100CIL020200	140,00
F100CI015	90,00	F100CI028	140,00	F100CIL025200	160,00
F100CI016	90,00	F100CI030	140,00	F100CILSET	280,00
F100CI017	90,00	F100CI032	140,00		
F100CI018	90,00	F100CISSET	250,00		

Per spallamento 90° a manicotto APKT 1003 senza fori

PAGINA 24 CATALOGO



	€
F100MN040	180,00
F100MN050	210,00
F100MN063	240,00

Per spallamenti 90° stelo cilindrico APKT1604 senza fori

PAGINA 25 CATALOGO



	€	€	SERIE LUNGA	€
F100CC02520	110,00	F100CCL2520200	130,00	
F100CC02525	110,00	F100CCL2525200	140,00	
F100CC02825	130,00	F100CCL2525300	160,00	
F100CC03025	130,00	F100CCL3225200	160,00	
F100CC03225	140,00	F100CCL3232200	160,00	
F100CC03232	140,00	F100CC03232300	190,00	
F100CC03532	160,00			
F100CC04032	180,00			

Per spallamento 90° a manicotto APKT 1604 senza fori

PAGINA 25 CATALOGO



	€
F100MA040	150,00
F100MA050	170,00
F100MA063	190,00
F100MA080	250,00
F100MA100	280,00

Per spallamento 45° a manicotto SEHT 1204

PAGINA 26 CATALOGO



	€
F200MA040	170,00
F200MA050	200,00
F200MA063	230,00
F200MA080	270,00
F200MA100	300,00
F200MA125	360,00
F200MA160	510,00



	€
F600Z401225	320,00
F600Z501232	330,00

## Per cave a T



	€
F600210912	230,00
F600251116	250,00
F600321420	290,00
F600401725	310,00
F600502132	340,00

## FRESE concave a una sede



	€
F500CC17025	85,00
F500CC17050	85,00
F500CC27070	100,00
F500CC32100	120,00
F500CC50135 CM3	240,00
F500CC50150 CM3	240,00
F500CC50135D d.20	240,00
F500CC50150D d.20	240,00

## FRESE concave A 2 SEDI



	€
F500CC22025	100,00
F500CC22050	100,00
F500CC32070	120,00
F500CC50100	140,00
F500CC50135D d.20	280,00
F500CC50150D d.20	280,00
F500CC6020D d.20	300,00

## SET FRESE A 2 SEDI

KITF500CC22

€  
360,00

## FRESE convesse a una SEDE



	€
F500CV24060	90,00
F500CV27080	110,00
F500CV27100	110,00

NB. : INSERTI CONCAVI E CONVESSI A PAG 31



	€	€	
F9001006	55,00	F9002209	60,00
F9001106	55,00	F9002309	60,00
F9001206	55,00	F9002409	60,00
F9001306	55,00	F9002509	60,00
F9001406	55,00	F9002609	70,00
F9001506	55,00	F9002709	70,00
F9001606	55,00	F9002809	70,00
F9001709	60,00	F9002909	70,00
F9001809	60,00	F9003009	70,00
F9001909	60,00	F9003109	70,00
F9002009	60,00	F9003209	70,00
F9002109	60,00	F9003309	70,00
		F9003409	70,00

## BARENI DI PREFINITURA



	€	€	
UI600098	70,00	UI600208	90,00
UI600108	70,00	UI600218	90,00
UI600118	70,00	UI600228	90,00
UI600128	70,00	UI600238	100,00
UI600138	70,00	UI600248	100,00
UI600148	70,00	UI600258	100,00
UI600158	75,00	UI600268	100,00
UI600168	75,00	UI600278	120,00
UI600178	75,00	UI600288	120,00
UI600188	75,00	UI600298	120,00
UI600198	75,00	UI600308	120,00
		UI600318	120,00

## Frese per scanalare e taglio 700



	€	€	
F7006304	650,00	F70016004	1.200,00
F7006305	650,00	F70016005	1.200,00
F7006306	650,00	F70016006	1.100,00
F7008004	700,00	F70016007	1.100,00
F7008005	700,00	F70016008	1.100,00
F7008006	700,00	F70016009	1.100,00
F70010004	800,00	F70016010	1.100,00
F70010005	800,00	F70016012	1.100,00
F70010006	800,00	F70016014	1.100,00
F70010007	800,00	F70020004	1.600,00
F70010008	800,00	F70020005	1.600,00
F70010009	800,00	F70020006	1.400,00
F70010010	800,00	F70020008	1.400,00
F70012504	900,00	F70020010	1.400,00
F70012505	900,00	F70020012	1.400,00
F70012506	900,00	F70020014	1.400,00
F70012508	900,00	F70025008	1.800,00
F70012510	900,00	F70025010	1.800,00
F70012512	900,00	F70025012	1.800,00
		F70025014	1.800,00

NB: Frese per scanalature e taglio 700m; non più costruite.



	€
F40016208	160,00
F40020310	170,00
F40025412	180,00
F40032516	190,00

Testine modulari APKT 1604



	€
F41025212	180,00
F41032316	190,00
F41040416	210,00

Testine modulari RDHX 0702 - RDHX 1003



	€
F43016308	180,00
F43020410	190,00
F43025512	210,00
F43032616	220,00
F44020210	180,00
F44025312	190,00
F44032416	210,00
F44035416	220,00
F44042616	240,00

2D 2 Volte il diametro L/D = 2

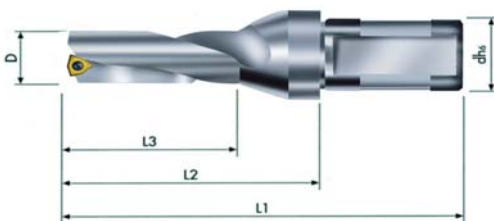

	€		€
PINS2WC0315	220,00	PINS2WC0637	295,00
PINS2WC0316	220,00	PINS2WC0638	295,00
PINS2WC0317	220,00	PINS2WC0639	295,00
PINS2WC0318	220,00	PINS2WC0640	295,00
PINS2WC0319	220,00	PINS2WC0641	295,00
PINS2WC0320	220,00	PINS2WC0842	325,00
PINS2WC0421	242,00	PINS2WC0843	325,00
PINS2WC0422	242,00	PINS2WC0844	325,00
PINS2WC0423	242,00	PINS2WC0845	325,00
PINS2WC0424	242,00	PINS2WC0846	325,00
PINS2WC0425	242,00	PINS2WC0847	325,00
PINS2WC0526	265,00	PINS2WC0848	325,00
PINS2WC0527	265,00	PINS2WC0849	360,00
PINS2WC0528	265,00	PINS2WC0850	360,00
PINS2WC0529	265,00	PINS2WC0851	360,00
PINS2WC0530	265,00	PINS2WC0852	360,00
PINS2WC0631	285,00	PINS2WC0853	360,00
PINS2WC0632	285,00	PINS2WC0854	360,00
PINS2WC0633	285,00	PINS2WC0855	360,00
PINS2WC0634	285,00	PINS2WC0856	360,00
PINS2WC0635	285,00	PINS2WC0857	360,00
PINS2WC0636	285,00	PINS2WC0858	360,00
		PINS2WC0859	450,00
		PINS2WC0860	450,00

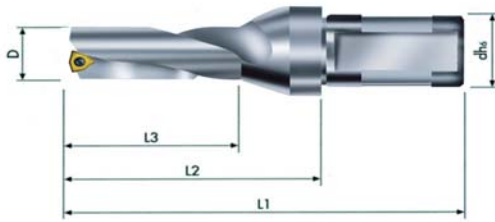

	€	€	
PINS3WC0315	220,00	PINS3WC0636	285,00
PINS3WC03155	220,00	PINS3WC0637	295,00
PINS3WC0316	220,00	PINS3WC0638	295,00
PINS3WC03165	220,00	PINS3WC0639	295,00
PINS3WC0317	220,00	PINS3WC0640	295,00
PINS3WC03175	220,00	PINS3WC0641	295,00
PINS3WC0318	220,00	PINS3WC0842	325,00
PINS3WC03185	220,00	PINS3WC0843	325,00
PINS3WC0319	220,00	PINS3WC0844	325,00
PINS3WC03195	220,00	PINS3WC0845	325,00
PINS3WC0320	220,00	PINS3WC0846	325,00
PINS3WC0421	242,00	PINS3WC0847	325,00
PINS3WC0422	242,00	PINS3WC0848	325,00
PINS3WC0423	242,00	PINS3WC0849	325,00
PINS3WC0424	242,00	PINS3WC0850	360,00
PINS3WC0425	242,00	PINS3WC0851	360,00
PINS3WC0526	265,00	PINS3WC0852	360,00
PINS3WC0527	265,00	PINS3WC0853	360,00
PINS3WC0528	265,00	PINS3WC0854	360,00
PINS3WC0529	265,00	PINS3WC0855	360,00
PINS3WC0530	265,00	PINS3WC0856	360,00
PINS3WC0631	285,00	PINS3WC0857	360,00
PINS3WC0632	285,00	PINS3WC0858	360,00
PINS3WC0633	285,00	PINS3WC0859	450,00
PINS3WC0634	285,00	PINS3WC0860	450,00
PINS3WC0635	285,00		

## Ampliamento gamma punte ad inserti 3D - L/D = 3

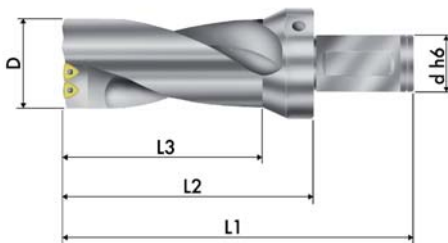

	€
PINS3WC0564	930,00
PINS3WC0569	930,00
PINS3WC0670	1.200,00
PINS3WC0675	1.200,00
PINS3WC0680	1.200,00
PINS3WC0685	1.200,00
PINS3WC0890	1.750,00
PINS3WC0895	1.750,00

## 4D - 4 Volte il diametro - L/D = 4

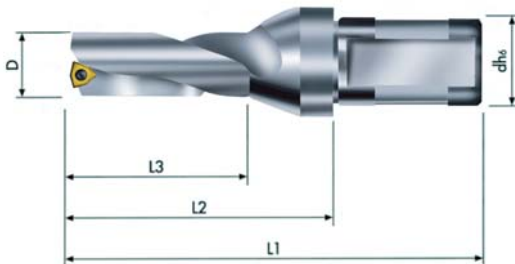

	€	€	
PINS4WC0318	330,00	PINS4WC0530	350,00
PINS4WC0319	330,00	PINS4WC0631	390,00
PINS4WC0320	330,00	PINS4WC0632	390,00
PINS4WC0421	330,00	PINS4WC0633	390,00
PINS4WC0422	330,00	PINS4WC0634	390,00
PINS4WC0423	330,00	PINS4WC0635	390,00
PINS4WC0424	330,00	PINS4WC0636	390,00
PINS4WC0425	330,00	PINS4WC0637	400,00
PINS4WC0526	350,00	PINS4WC0638	400,00
PINS4WC0527	350,00	PINS4WC0639	400,00
PINS4WC0528	350,00	PINS4WC0640	400,00
PINS4WC0529	350,00		

## 5D - 5 Volte il diametro - L/D = 5

NEW

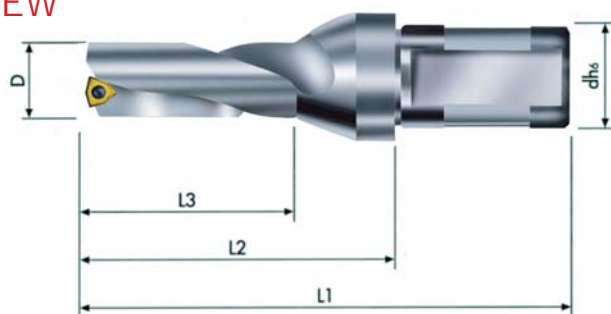

	€		€
PINS5WC0424	450,00	PINS5WC0632	530,00
PINS5WC0425	450,00	PINS5WC0633	530,00
PINS5WC0526	480,00	PINS5WC0634	530,00
PINS5WC0527	480,00	PINS5WC0635	530,00
PINS5WC0528	480,00	PINS5WC0636	540,00
PINS5WC0529	480,00	PINS5WC0637	540,00
PINS5WC0530	480,00	PINS4WC0638	540,00
PINS5WC0631	530,00	PINS4WC0639	540,00
		PINS4WC0640	540,00

## 4D - 10D Punta con inserto a cuspidi L/D = 4/10

DEPLIANT BLU

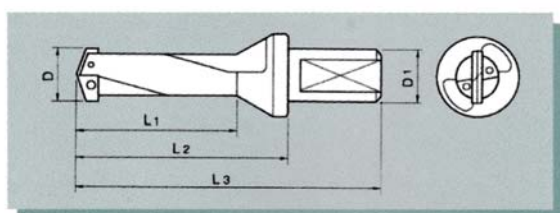

	€		€
PINS091135	210,00	PINS1824168	320,00
PINS11512565	220,00	PINS1824218	400,00
PINS115125115	260,00	PINS253597	340,00
PINS1317560	220,00	PINS2535137	400,00
PINS1317585	247,00	PINS2535187	450,00
PINS13175114	270,00	PINS2535257	500,00
PINS182478	270,00	PINS3647300	670,00
PINS1824118	290,00	PINS4865300	790,00

## BARENI registrabili standard

PAGINA 43 CATALOGO

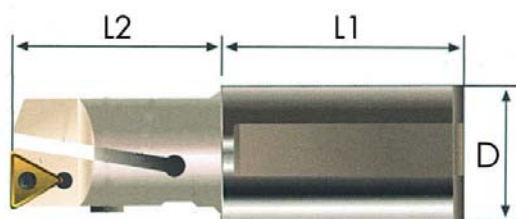

	€	SET 7 PEZZI	€
AIBAR0607	142,00	AIBARSET0730	910,00
AIBAR0708	142,00		
AIBAR0810	142,00	SET 9 PEZZI	€
AIBAR1012	150,00	AIBARSET1050	1.450,00
AIBAR1215	160,00		
AIBAR1520	165,00		
AIBAR2025	175,00		
AIBAR2530	180,00		
AIBAR3035	195,00		
AIBAR3540	210,00		
AIBAR4045	240,00		
AIBAR4550	260,00		

## BARENI registrabili corti

PAGINA 44 CATALOGO

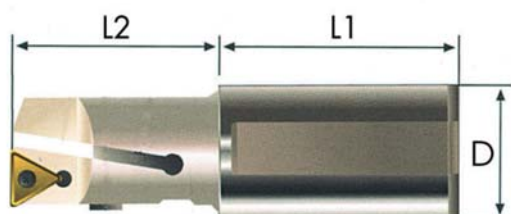

	€
AIBARC3035	175,00
AIBARC3540	195,00
AIBARC4045	210,00
AIBARC4550	240,00

## BARENI registrabili lunghi

PAGINA 44 CATALOGO

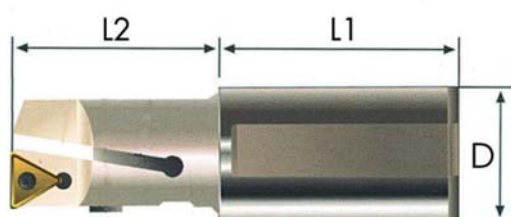

	€
AIBARL1215	195,00
AIBARL1520	210,00
AIBARL2025	210,00
AIBARL2530	220,00
AIBARL3035	230,00
AIBARL3540	260,00



	€
BARMAX30	530,00
BARMAX40	550,00
BARMAX50	580,00
BARMAX75	620,00
BARMAX100	700,00
BARMAX150	870,00
BARMAX220	950,00

**NB. Il prezzo comprende: una testina registrabile + la cartuccia base escluso il misurabar.**

Ogni misurabar è da ordinare a parte, al prezzo, per tutti uguale, di **€120,00**

TCMT - Utensili frontali



DESTRA	€	SINISTRA	€
UER20MTCM0940	180,00	UEL20MTCM0940	180,00
UER20MTCM0960	180,00	UEL20MTCM0960	180,00
UER25MTCM0980	190,00	UEL25MTCM0980	190,00
UER25MTCM1180	190,00	UEL25MTCM1180	190,00
UER32MTCM16100	220,00	UEL32MTCM16100	220,00

RCMT - Utensili frontali



DESTRA	€	SINISTRA	€
UER20MRCM0840	200,00	UEL20MRCM0840	200,00
UER20MRCM0860	200,00	UEL20MRCM0860	200,00
UER25MRCM0880	230,00	UEL25MRCM0880	230,00
UER25MRCM1080	230,00	UEL25MRCM1080	230,00
UER32MRCM12100	230,00	UEL32MRCM12100	230,00
UER32MRCM12L100	270,00	UEL32MRCM12L100	270,00

Utensili per smussi Interni DCMT 55°



DESTRA	€	SINISTRA	€
UIS12MSDNCR07	75,00	UIS12MSDNCL07	75,00
UIS16MSDNCR07	75,00	UIS16MSDNCL07	75,00
UIS20RSDNCR11	85,00	UIS20RSDNCL11	85,00
UIS25SSDNCR11	95,00	UIS25SSDNCL11	95,00

Utensili per smussi Interni DNMG 55°



DESTRA	€	SINISTRA	€
UIS32TPDNNR15	170,00	UIS32TPDNNL15	170,00
UIS40UPDNNR15	190,00	UIS40UPDNNL15	190,00





DESTRA	€	SINISTRA	€
UIS16MSSSCR09	75,00	UIS16MSSSCL09	75,00
UIS20RSSSCR09	80,00	UIS20RSSSCL09	80,00
UIS25SSSSCR09	85,00	UIS25SSSSCL09	85,00
UIS32TSSSCR12	140,00	UIS32TSSSCL12	140,00
UIS40TSSSCR12	160,00	UIS40TSSSCL12	160,00

## Utensili con stelo rinforzato CCMT



DESTRA	€	SINISTRA	€
UISCLCRX0608	35,00	UISCLCLX0608	35,00
UISCLCRX0810	40,00	UISCLCLX0810	40,00
UISCLCRX1012	45,00	UISCLCLX1012	45,00
UISCLCRX1216	50,00	UISCLCLX1216	50,00
UIETSCLCRX	140,00	UIETSCLCLX	140,00

## UTENSILI per filettare 1990FG



	€
R/L1990FG161616	92,00
R/L1990FG202016	92,00
R/L1990FG252516	100,00
R/L1990FG322516	105,00
R/L1990FG252522	100,00
R/L1990FG323222	105,00
R/L1990FG404022	160,00

## UTENSILI per filettare 1990KF



	€
R/L1990KF1011	80,00
R/L1990KF1211	80,00
R/L1990KF1616	85,00
R/L1990KF2016	105,00
R/L1990KF2516	120,00
R/L1990KF3216	140,00
R/L1990KF4016	190,00
R/L1990KF2022	105,00
R/L1990KF2522	120,00
R/L1990KF3222	140,00
R/L1990KF4022	190,00

## UTENSILI per fantina mobile - stelo rettificato - CCMT



DESTRA	€	SINISTRA	€
SCLCR10M06F SCLCR1010M06	75,00	SCLCL10M06F SCLCL1010M06	75,00
SCLCR12M06F SCLCR1212M06	75,00	SCLCL12M06F SCLCL1212M06	75,00
SCLCR12M09F SCLCR1212M09	75,00	SCLCL12M09F SCLCL1212M09	75,00
SCLCR16M09F SCLCR1616M09	80,00	SCLCL16M09F SCLCL1616M09	80,00
SCLCR16M12F SCLCR1616M12	80,00	SCLCL16M12F SCLCL1616M12	80,00

R = DESTRO L = SINISTRO N = NEUTRO



DESTRA	€	SINISTRA	€
<b>SDJCR10M07F</b> SDJCR1010M07	<b>75,00</b>	<b>SDJCL10M07F</b> SDJCL1010M07	<b>75,00</b>
<b>SDJCR12M07F</b> SDJCR1212M07	<b>75,00</b>	<b>SDJCL12M07F</b> SDJCL1212M07	<b>75,00</b>
<b>SDJCR12M11F</b> SDJCR1212M11	<b>75,00</b>	<b>SDJCL12M11F</b> SDJCL1212M11	<b>75,00</b>
<b>SDJCR16M11F</b> SDJCR1616M11	<b>80,00</b>	<b>SDJCL16M11F</b> SDJCL1616M11	<b>80,00</b>



DESTRA	€	SINISTRA	€
<b>SVJCR10M11</b> SVJCR1010M11	<b>75,00</b>	<b>SVJCL10M11</b> SVJCL1010M11	<b>75,00</b>
<b>SVJCR12M11</b> SVJCR1212M11	<b>75,00</b>	<b>SVJCL12M11</b> SVJCL1212M11	<b>75,00</b>
<b>SVJCR16M11</b> SVJCR1616M11	<b>80,00</b>	<b>SVJCL16M11</b> SVJCL1616M11	<b>80,00</b>

## UTENSILI PER TORNITURA ESTERNA

R=DESTRO L=SINISTRO N=NEUTRO

### CKJN 93°



K=93°

	€
CKJNR/L2020K16	102,00
CKJNR/L2525M16	107,00
CKJNR/L3225P16	120,00
CKJNR/L4025R16	147,00
CKJNR/L5032T16	215,00

### MTJN 93°



K=93°

	€
MTJNR/L1616M16	98,00
MTJNR/L2020K16	63,00
MTJNR/L2525M16	68,00
MTJNR/L3225P16	78,00
MTJNR/L2525M22	68,00
MTJNR/L3225P22	78,00
MTJNR/L3232P22	80,00
MTJNR/L4025S22	136,00
MTJNR/L5032T22	162,00

### MTENN 60°



K=60°

	€
MTENN2020K16	63,00
MTENN2525M16	68,00
MTENN3225P16	78,00
MTENN3232P16	80,00
MTENN2525M22	68,00
MTENN3225P22	78,00
MTENN3232P22	80,00



	€
VVJNR/L2020K16	102,00
VVJNR/L2525K16	105,00
VVJNR/L3225K16	114,00

## VVVN 72° 30'



	€
VVVN2020K16	102,00
VVVN2525K16	105,00
VVVN3225P16	114,00

## MWLN 95°



	€
MWLN/L2020K08	63,00
MWLN/L2525M08	68,00
MWLN/L3225P08	78,00
MWLN/L3232K08	80,00

## PCKN 15°



	€	€	
PCKNR/L1616H12	63,00	PCKNR/L2525M19	68,00
PCKNR/L2020K12	63,00	PCKNR/L3225P19	78,00
PCKNR/L2525M12	68,00	PCKNR/L3232P19	80,00
PCKNR/L3225P12	78,00	PCKNR/L4040S19	136,00
PCKNR/L2525M16	68,00		
PCKNR/L3225P16	78,00		
PCKNR/L3232P16	80,00		

## PCLN 95°

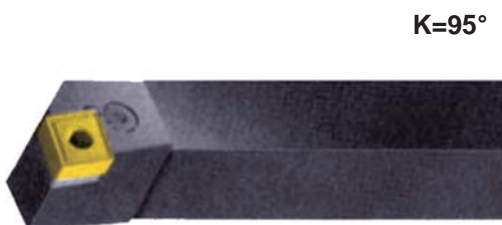

	€	€	
PCLNR/L1616H12	63,00	PCLNR/L2525M19	68,00
PCLNR/L2020K12	63,00	PCLNR/L3225P19	78,00
PCLNR/L2525M12	68,00	PCLNR/L3232P19	80,00
PCLNR/L3225P12	78,00	PCLNR/L4040S19	136,00
PCLNR/L3232P12	80,00	PCLNR/L4040S25	147,00
PCLNR/L2525M16	68,00	PCLNR/L5050T25	198,00
PCLNR/L3225P16	78,00		
PCLNR/L3232P16	80,00		
PCLNR/L4040P16	136,00		

K=75°



	€
PCBNR/L2020K12	63,00
PCBNR/L2525M12	68,00
PCBNR/L2525M16	68,00
PCBNR/L3225P16	78,00
PCBNR/L3232P16	80,00
PCBNR/L3232P19	80,00
PCBNR/L4040S19	136,00
PCBNR/L4040S25	147,00
PCBNR/L5050S25	198,00

## PDJN 93°

K=93°



	€
PDJNR/L2020K15	63,00
PDJNR/L2525M15	68,00
PDJNR/L3225P15	78,00
PDJNR/L3232P15	80,00
PDJNR/L4025S15	136,00
PDJNR/L5032T15	198,00

## PDNN 63°

K=63°



	€
PDNNR/L2020K15	63,00
PDNNR/L2525M15	68,00
PDNNR/L3225P15	78,00
PDNNR/L3232P15	80,00
PDNNR/L4025S15	136,00
PDNNR/L5032T15	198,00

R = DESTRO L = SINISTRO N = NEUTRO

## PSKN 75°

K=75°



	€
PSKNR/L2020K12	63,00
PSKNR/L2525M12	68,00
PSKNR/L3225P12	78,00
PSKNR/L2525M15	63,00
PSKNR/L3232P15	80,00
PSKNR/L3232P19	80,00
PSKNR/L4040S19	136,00
PSKNR/L5050T25	198,00

## PSSN 45°

K=45°



	€
PSSNR/L2020K12	63,00
PSSNR/L2525M12	68,00
PSSNR/L3225P12	78,00
PSSNR/L2525M15	63,00
PSSNR/L3232P15	80,00
PSSNR/L3232P19	80,00
PSSNR/L4040S19	136,00
PSSNR/L4040S25	147,00
PSSNR/L5050T25	198,00

K=45°



	€
PWLNR/L1616H06	63,00
PWLNR/L2020K06	63,00
PWLNR/L2525M06	68,00
PWLNR/L2020K08	63,00
PWLNR/L2525M08	68,00
PWLNR/L3225P08	78,00
PWLNR/L3232P08	80,00

## SCLC 95°

K=95°



	€
SCLCR/L0808D06	56,00
SCLCR/L1010E06	56,00
SCLCR/L1212F06	56,00
SCLCR/L1212F09	56,00
SCLCR/L1616H09	62,00
SCLCR/L2020K09	68,00
SCLCR/L2020K12	68,00
SCLCR/L2525M12	74,00

## SDJC 93°

K=93°



	€
SDJCR/L1010E07	56,00
SDJCR/L1212F07	56,00
SDJCR/L1616H07	62,00
SDJCR/L2020K07	68,00
SDJCR/L1212F11	56,00
SDJCR/L1616H11	62,00
SDJCR/L2020K11	68,00
SDJCR/L2525M11	74,00

## SDNCN 63°

K=63°



	€
SDNCN1010E07	56,00
SDNCN1212F07	56,00
SDNCN1616H11	62,00
SDNCN2020K11	68,00
SDNCN2525M11	74,00

## SRDC 90°

K=90°



	€
SRDCR/L1212F06	55,00
SRDCR/L1616H06	62,00
SRDCR/L2020K06	68,00
SRDCR/L2525M06	74,00
SRDCR/L1616H08	62,00
SRDCR/L2020K08	68,00
SRDCR/L2525M08	74,00
SRDCR/L2020K10	68,00
SRDCR/L2525M10	74,00
SRDCR/L2020K12	68,00
SRDCR/L2525M12	74,00



K=90°

	€
SRDCN1212F06	55,00
SRDCN1616H06	62,00
SRDCN2020K06	68,00
SRDCN2525M06	74,00
SRDCN1616H08	62,00
SRDCN2020K08	68,00
SRDCN2525M08	74,00
SRDCN2020K10	68,00
SRDCN2525M10	74,00
SRDCN2020K12	68,00
SRDCN2525M12	74,00

## STGC 91°



K=91°

	€
STGCR/L0808D09	55,00
STGCR/L1010E09	55,00
STGCR/L1212F11	55,00
STGCR/L1616H11	62,00
STGCR/L1616H16	62,00
STGCR/L2020K16	68,00
STGCR/L2525M16	74,00

## STFC 91°



K=91°

	€
STFCR/L0808D09	55,00
STFCR/L1010E09	55,00
STFCR/L1212F11	55,00
STFCR/L1616H11	62,00
SDJCR/L1616H16	62,00
SDJCR/L2020K16	68,00
SDJCR/L2525M16	74,00

## SVJB 93°



K=93°

	€
SVJBR/L2020K16	74,00
SVJBR/L2525M16	68,00
SVJBR/L3225P16	86,00

## SVHB 107° 30'



K=107° 30'

	€
SVHBR/L2020K16	74,00
SVHBR/L2525M16	78,00
SVHBR/L3225P16	86,00

## SVVB 72° 30'



K=72° 30'

	€
SVVBN2020K16	74,00
SVVBN2525M16	78,00
SVVBN3225P16	86,00

## SVJC 93°

PAGINA 63 CATALOGO



K=93°

SVJCR/L2020K16	74,00
SVJCR/L2525M16	78,00
SVJCR/L3225P16	86,00

## SVHC 107° 30'

PAGINA 63 CATALOGO



K=107° 30'

SVHCR/L2020K16	74,00
SVHCR/L2525M16	78,00
SVHCR/L3225P16	86,00

## SVVCN 72° 30'

PAGINA 63 CATALOGO



K=72° 30'

SVVCNR/L2020K16	74,00
SVVCNR/L2525M16	78,00
SVVCNR/L3225P16	86,00

## UTENSILI PER TORNITURA INTERNA

R=DESTRO L=SINISTRO N=NEUTRO

## CKUN 93°

PAGINA 66 CATALOGO



K=93°

S25TCKUNR/L16	152,00
S32TCKUNR/L16	189,00
S40TCKUNR/L16	231,00

## CSKP 75°

PAGINA 66 CATALOGO



K=75°

S16RCSKPR/L09	88,00
S20SCSKPR/L09	105,00
S25TCSKPR/L12	126,00
S32UCSKPR/L12	162,00
S40VCSKPR/L12	195,00

## CTFP 91°

PAGINA 66 CATALOGO



K=91°

S12MCTFPR/L11	78,00
S16RCTFPR/L11	88,00
S20SCTFPR/L11	105,00
S16RCTFPR/L16	88,00
S20RCTFPR/L16	105,00
S25TCTFPR/L16	126,00
S32UCTFPR/L16	162,00
S40VCTFPR/L16	195,00

## MTFN 91°

PAGINA 67 CATALOGO

**K=91°**



	€
S25TMFNRL16	151,00
S32UMTFNRL16	172,00
S40VMTFNRL16	208,00
S50WMTFNRL16	252,00
S32UMTFNRL22	172,00
S40VMTFNRL22	208,00
S50WMTFNRL22	252,00
S60ZMTFNRL16	530,00
S60ZMTFNRL22	530,00

Utensili forati	€
A25RMTFNRL16	162,00
A32SMTFNRL16	198,00
A40TMTFNRL16	236,00
A50UMTFNRL16	284,00
A32SMTFNRL22	198,00
A40TMTFNRL22	236,00
A50UMTFNRL22	284,00

## MWLN 95°

PAGINA 67 CATALOGO

**K=95°**



	€
S25TMWLNRL08	151,00
S32UMWLNRL08	172,00
S40VMWLNRL08	208,00
S50WMWLNRL08	252,00
S60ZMWLNRL08	530,00

Utensili forati	€
A25RMWLNRL08	162,00
A32SMWLNRL08	198,00
A40TMWLNRL08	236,00
A50UMWLNRL08	284,00

## PCLN 95°

PAGINA 68 CATALOGO

**K=95°**



	€
S25TPCLNRL12	151,00
S32UPCLNRL12	172,00
S40VPCLNRL12	208,00
S50WPCLNRL12	252,00
S40VPCLNRL16	208,00
S50WPCLNRL16	252,00
S50WPCLNRL19	252,00
S60ZPCLNRL12	530,00
S60ZPCLNRL16	530,00
S60ZPCLNRL19	530,00

Utensili forati	€
A25RPCLNRL12	162,00
A32SPCLNRL12	198,00
A40TPCLNRL12	236,00
A50UPCLNRL12	284,00
A40TPCLNRL16	198,00
A50UPCLNRL16	236,00
A50UPCLNRL19	284,00

## PCLNN 95°

PAGINA 68 CATALOGO

**K=95°**



	€
S32RPCLNN12	448,00
S40TPCLNN12	496,00
S50WPCLNN16	570,00

## PDUN 93°

PAGINA 69 CATALOGO

**K=93°**



	€
S25SPDUNRL15	151,00
S32UPDUNRL15	172,00
S40VPDUNRL15	208,00
S50WPDUNRL15	252,00
S60ZPDUNRL15	530,00

Utensili forati	€
A25RPDUNRL15	162,00
A32SPDUNRL15	198,00
A40TPDUNRL15	236,00
A50UPDUNRL15	284,00

## PSKN 75°

PAGINA 69 CATALOGO

**K=75°**



	€
S25TPSKNRL12	151,00
S32UPSKNRL12	172,00
S40VPSKNRL12	208,00
S40VPSKNRL15	252,00
S50WPSKNRL15	252,00
S50WPSKNRL19	252,00





K=95°

	€	Utensili forati	€
S08KSCLCR/L06	65,00	A08HSCLCR/L06	76,00
S10KSCLCR/L06	65,00	A10HSCLCR/L06	76,00
S12MSCLCR/L06	69,00	A12KSCLCR/L06	82,00
S16RSCLCR/L06	78,00	A16MSCLCR/L06	99,00
S12MSCLCR/L09	69,00	A12KSCLCR/L09	82,00
S16RSCLCR/L09	78,00	A16MSCLCR/L09	99,00
S20SSCLCR/L09	88,00	A20QSCLCR/L09	108,00
S25TSCLCR/L09	110,00	A25RSCLCR/L09	125,00
S20SSCLCR/L12	88,00	A20QSCLCR/L12	108,00
S25TSCLCR/L12	110,00	A25RSCLCR/L12	125,00
S32USCLCR/L12	136,00	A32SSCLCR/L12	162,00
S40VSCLCR/L12	173,00	A40TSCLCR/L12	199,00

## SDUC 93°

PAGINA 71 CATALOGO

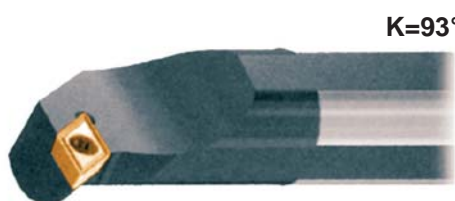

K=93°

	€	Utensili forati	€
S10KSDUCR/L07	65,00	A10HSDUCR/L07	76,00
S12MSDUCR/L07	69,00	A12KSDUCR/L07	82,00
S16RSDUCR/L07	78,00	A16MSDUCR/L07	99,00
S16RSDUCR/L11	78,00	A16MSDUCR/L11	99,00
S20SSDUCR/L11	88,00	A20QSDUCR/L11	108,00
S25TSDUCR/L11	110,00	A25RSDUCR/L11	125,00
S32USDUCR/L11	136,00	A32SSDUCR/L11	162,00
S40VSDUCR/L11	179,00	A40TSDUCR/L11	199,00

## SDQC 107° 30'

PAGINA 71 CATALOGO



K=107° 30'

	€	Utensili forati	€
S12MSDQCR/L07	69,00	A12KSDQCR/L07	82,00
S16RSDQCR/L07	78,00	A16MSDQCR/L07	99,00
S16RSDQCR/L11	78,00	A16MSDQCR/L11	99,00
S20SSDQCR/L11	88,00	A20QSDQCR/L11	108,00
S25TSCLCR/L11	110,00	A25RSDQCR/L11	125,00
S32USDQCR/L11	136,00	A32SSDQCR/L11	162,00
S40VSCLCR/L11	173,00	A40TSDQCR/L11	199,00

## SDUC-EX 93°

PAGINA 72 CATALOGO



K=93°

	€	Utensili forati	€
S16RSDUCR/L07-EX			95,00
S20SSDUCR/L07-EX			99,00
S25TSDUCR/L07-EX			126,00
S32USDUCR/L11-EX			152,00

## STFC 91°

PAGINA 72 CATALOGO



K=91°

	€	Utensili forati	€
S10KSTFCR/L09	65,00	A10HSTFCR/L09	76,00
S12MSTFCR/L09	69,00	A12KSTFCR/L09	82,00
S10KSTFCR/L11	65,00	A10HSTFCR/L11	76,00
S12MSTFCR/L11	69,00	A12KSTFCR/L11	82,00
S16RSTFCR/L11	78,00	A16MSTFCR/L11	99,00
S20SSTFCR/L11	88,00	A20QSTFCR/L11	108,00
S16RSTFCR/L16	78,00	A16MSTFCR/L16	99,00
S20SSTFCR/L16	88,00	A20KSTFCR/L16	108,00
S25TSTFCR/L16	110,00	A25RSTFCR/L16	125,00
S32USTFCR/L16	136,00	A32SSTFCR/L16	162,00
S40VSTFCR/L16	173,00	A40TSTFCR/L16	199,00



K=93°

	€
S25TSVUCR/L16	110,00
S32USVUCR/L16	149,00
S40VSVUCR/L16	186,00

## SVQC 107° 30'



K=107° 30'

	€
S25TSVQCR/L16	110,00
S32USVQCR/L16	149,00
S40VSVQCR/L16	186,00

## SVOC 140°



K=140°

	€
S25TSVOCR/L16	161,00
S32USVOCR/L16	196,00
S40VSVOCR/L16	219,00

## CARTUCCE

R = DESTRO L = SINISTRO N = NEUTRO

## TCMA 90°

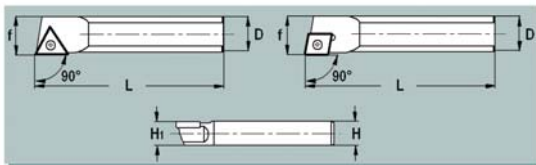

	€
TCMAR/L 08,06	45,00
TCMAR/L 10,06	46,00
TCMAR/L 12,06	47,00
TCMAR/L 16,16	52,00
TCMAR/L 20,16	65,00
TCMAR/L 25,16	70,00

## TCMB 60°

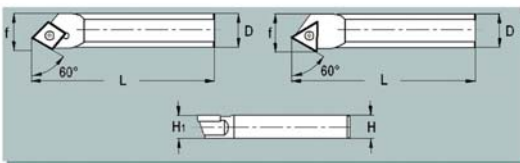

	€
TCMBR/L 08,06	45,00
TCMBR/L 10,06	46,00
TCMBR/L 12,06	47,00
TCMBR/L 16,16	52,00
TCMBR/L 20,16	65,00
TCMBR/L 25,16	70,00

## TCMC 45°

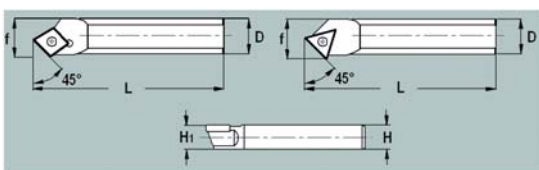

	€
TCMCR/L 08,06	45,00
TCMCR/L 10,06	46,00
TCMCR/L 12,06	47,00
TCMCR/L 16,16	52,00
TCMCR/L 20,16	65,00
TCMCR/L 25,16	70,00

## PTFN 90°

PAGINA 77 CATALOGO

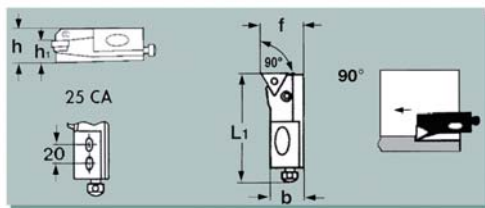

	€
PTFNR/L12CA-16	103,00
PTFNR/L16CA-16	106,00
PTFNR/L20CA-16	120,00

## PTWN 60°

PAGINA 77 CATALOGO

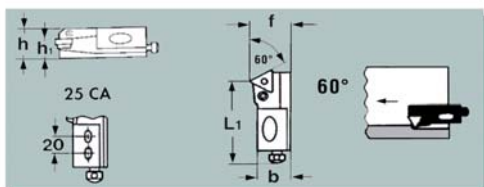

	€
PTWNR/L12CA-16	103,00
PTWNR/L16CA-16	106,00
PTWNR/L20CA-16	120,00

## PSKN 75°

PAGINA 78 CATALOGO

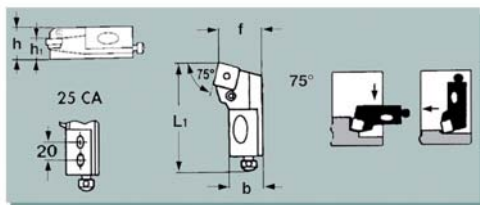

	€
PSKNR/L12CA-12	103,00
PSKNR/L16CA-12	106,00
PSKNR/L20CA-15	120,00
PSKNR/L25CA-19	136,00

## PCLN 95°

PAGINA 79 CATALOGO

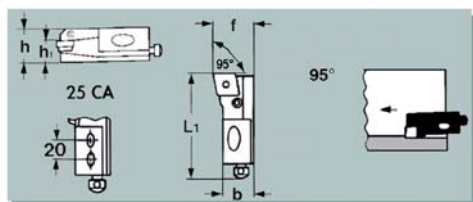

	€
PCLNR/L12CA-12	103,00
PCLNR/L16CA-12	106,00
PCLNR/L20CA-16	120,00
PCLNR/L25CA-19	136,00

## SSKC 75°

PAGINA 81 CATALOGO

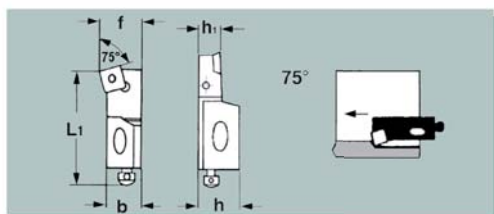

	€
SSKCR/L10CA-09	93,00
SSKCR/L12CA-12	93,00

## STFC 90°

PAGINA 81 CATALOGO

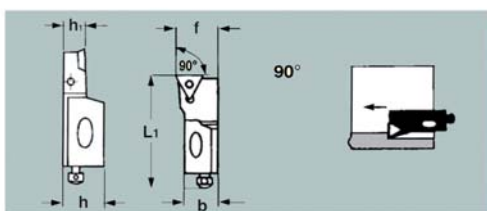

	€
STFCR/L10CA-11	93,00
STFCR/L12CA-16	93,00
STFCR/L16CA-16	98,00

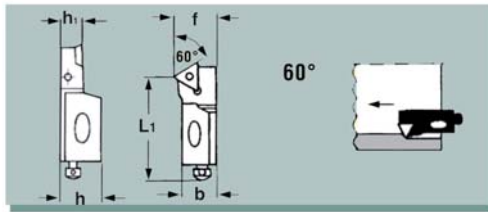

	€
STWCR/L10CA-11	93,00
STWCR/L12CA-16	93,00
STWCR/L16CA-16	98,00

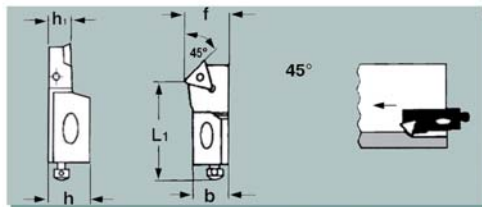

	€
STSCR/L10CA-11	93,00
STSCR/L12CA-16	93,00
STSCR/L16CA-16	98,00

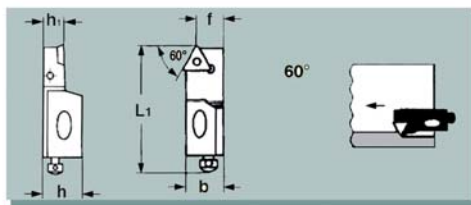

	€
STTCR/L10CA-11	93,00
STTCR/L12CA-16	93,00
STTCR/L16CA-16	98,00

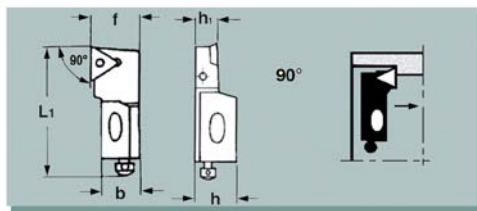

	€
STGCR/L10CA-11	93,00
STGCR/L12CA-16	93,00
STGCR/L16CA-16	98,00



	€
UEBASIC2020	155,00
UEBASIC2525	170,00

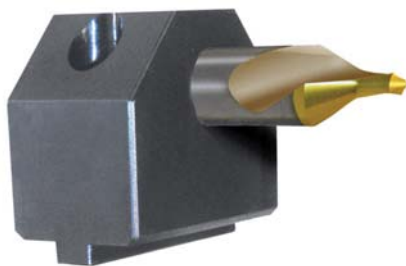

	€		€
TE2020315	95,00	TE2525315	105,00
TE2020040	95,00	TE2525040	105,00
TE2020050	95,00	TE2525050	105,00
TE2020063	95,00	TE2525063	105,00
TE2020080	95,00	TE2525080	105,00
TE2020100	95,00	TE2525100	105,00
TE2020120	95,00	TE2525120	105,00
TE2020125	95,00	TE2525125	105,00

UNIBOX



CONICO	€	CILINDRICO	€	WELTON	€
XCOUNIBOX	98,00	XCIUNIBOX	150,00	XWEUNIBOX	110,00
XCOFILACM1	17,00	XCFILA1	30,00	XWEFILA1	20,00
XCOFILACM2	17,00	XCFILA2	30,00	XWEFILA2	20,00
XCOFILACM3	17,00	XCFILA3	30,00	XWEFILA3	20,00
XCOFILACM4	17,00	XCFILA4	30,00	XWEFILA4	20,00
XCOMONTANTE	15,00	XCMONTANTE	15,00	XWEFILA5	20,00
				XWEFILA6	20,00
				XCOMONTANTE	15,00

MANDRINI PORTASEGHETTI



	€
XRID0508	89,00
XRID0806	78,00
XRID1008	78,00
XRID1310	78,00
XRID1612	84,00
XRID2216	89,00
XRID3225	200,00
XRIDSET	350,00

Appoggio canotto universale ACU



	€
ACU30	245,00
ACU40	260,00
ACU52	280,00
ACU62	300,00
ACU75	455,00
ACU90	500,00
ACU110	530,00
ACU130	530,00

Posizionatore per torni a controllo numerico



	€
Posizionatore per mandrino diametro 200	780,00
Posizionatore per mandrino diametro 250	780,00

# RICAMBI

	€		€		€
03 STAFFA	14.00	D2 SPINA	1,00	V20	5,50
04 STAFFA	14.00	D3 SPINA	1,00	V21	5,50
05 STAFFA	14.00	D3I SPINA	1,00	V22	3,00
06 STAFFA	14.00	D4 SPINA	1,00	V23	3,00
07 STAFFA	38.00	D5 SPINA	1,00	V24	3,00
08D STAFFA	10.00	E1 BASE	6,00	V25	3,00
08S STAFFA	10.00	E2 BASE	7,50	V26	3,00
112 LEVA	9.00	E2E BASE	17,50	V27	3,00
112 LEVA	4.00	E2I BASE	17,50	V28	3,00
AIR0607 SET RICAMBI AIBAR	9.00	E4 BASE	11,50	V35	3,00
AIR0708 SET RICAMBI AIBAR	9.00	F1 MOLLA	1,00	V35C	3,00
AIR0610 SET RICAMBI AIBAR	9.00	G11 MOLLA+SPINA	2,00	V36	3,00
AIR1012 SET RICAMBI AIBAR	9.00	G1 GRANO	1,00	V4	3,00
AIR1215 SET RICAMBI AIBAR	9.00	G2 GRANO	1,00	V40	3,00
AIR1520 SET RICAMBI AIBAR	9.00	G3 GRANO	1,00	V4C	3,00
AIR2025 SET RICAMBI AIBAR	9.00	G4 GRANO	1,00	V41	3,00
AIR2530 SET RICAMBI AIBAR	9.00	G5 GRANO	1,00	V45	3,00
AIR3035 SET RICAMBI AIBAR	11.00	G6 GRANO	1,00	V5	4,00
AIR3540 SET RICAMBI AIBAR	11.00	GS1 STAFFA	17,50	V53	4,50
AIR4045 SET RICAMBI AIBAR	13.00	GS2 STAFFA	17,50	V6	4,00
AIR4550 SET RICAMBI AIBAR	13.00	GS4 STAFFA	17,50	VTX3503	5,00
A1 BASE	7.00	K0 PERNO	3,00	VTX3504	5,00
A2 BASE	16.00	K1 PERNO	3,00	VTX405	5,00
A3 BASE	7.80	K2 PERNO	4,00	VTX408	5,00
A4 BASE	6.30	K3 PERNO	4,00	VV4	14,00
A5 BASE	12.30	K4 PERNO	5,00	VV4P	14,00
A6 BASE	5.30	K5 PERNO	5,00	W0 BASE	4,50
A6E BASE	12.60	L1 SPINA	1,00	W1 BASE	12,00
A6I BASE	12.60	L2 SPINA	1,00	W2 BASE	6,00
A7 BASE	7.60	L3 SPINA	1,00	W3 BASE	6,00
A8 BASE	4.50	P1 PERNO	7,50	W4 BASE	9,50
A10D BASE	8.50	P2 PERNO	11,50	W5 BASE	9,50
A10S BASE	8.50	R1 VITE	3,00	X0 RONDELLA	6,00
A16 BASE	8,50	R1C VITE	3,00	X01 BOCCOLA	5,00
B0 BASE	9.00	S0 VITE	4,50	X02 BOCCOLA	6,00
B1 LEVA	7.50	S3 STAFFA	7,50	X03 BOCCOLA	7,00
B2 LEVA	11.00	S3F PERNO	8,00	X04 VITE A CAPPELLO	18,00
B3 LEVA	9.00	SM1 BASE	81,00	Y1 BASE	11,00
B4 LEVA	8.00	SM2 BASE	81,00	Y2 BASE	11,00
B5 LEVA	11.00	T25 LEVA	28,00	Y3 BASE	34,00
B6 LEVA	16.00	T32 LEVA	28,00	Y4 BASE	13,00
BR2 BRUGOLA	1.00	T40 LEVA	30,00	Y5 BASE	6,50
BR2.5 BRUGOLA	1.00	T50 LEVA	30,00	Y6 BASE	29,00
BR3 BRUGOLA	1.00	T63 LEVA	35,00	Y7 BASE	20,00
BR4 BRUGOLA	1.00	T80 LEVA	35,00	Y8 BASE	29,00
BR5 BRUGOLA	1.00	T6 CACCIAVITE	6,00	Y9 BASE	72,00
C1 VITE	2,50	T7 CACCIAVITE	6,00	Z1 LEVA	11,50
C1C VITE	2,50	T8 CACCIAVITE	6,00	Z2 LEVA	9,50
C2 VITE	4,00	T9 CACCIAVITE	6,00	Z3 LEVA	10,50
C3 VITE	2,50	T15 CACCIAVITE	7,00	Z4 LEVA	14,00
C4 VITE	2,50	T20 CACCIAVITE	8,00	Z5 LEVA	12,00
C5 VITE	3,50	V0 VITE TORX	3,00	Z6 LEVA	19,00
C5C VITE	3,50	V10	3,00		
C6 VITE	4,00	V11	3,00		
D1 SPINA	1,00				

## NB. I PREZZI DEGLI INSERTI POSSONO VARIARE CON GLI AGGIORNAMENTI DEI LISTINI

INSERTI concavi P25		INSERTI convessi P25			
	€		€		€
IZADLC15A100 R1.0	9,50	IZADLR15A100 R1.0	8,50	CNMG 160408 GR NC3120	15,64
IZADLC15A150 R1.5	9,50	IZADLR15A150 R1.5	8,50	CNMG 160412 GR NC3120	15,64
IZADLC15A200 R2.0	9,50	IZADLR15A200 R2.0	8,50	CNMG 190408 HR NC3120	22,57
IZADLC15A250 R2.5	9,50	IZADLR15A250 R2.5	8,50	CNMG 190612 HR NC3120	22,57
IZADLC15A300 R3.0	9,50	IZADLR15A300 R3.0	8,50	DCMT 070204 C25 NC3120	7,75
IZADLC15A350 R3.5	9,50	IZADLR15A350 R3.5	8,50	DCMT 070208 C25 NC3120	7,75
IZADLC15A400 R4.0	9,50	IZADLR15A400 R4.0	8,50	DCMT 11T304 C25 NC3120	8,80
IZADLC15A450 R4.5	9,50	IZADLR15A450 R4.5	8,50	DCMT 11T308 C25 NC3120	8,80
IZADLC15A500 R5.0	9,50	IZADLR15A500 R5.0	8,50	DCMT 150404 UTI20T	11,90
IZADLC15A550 R5.5	9,50	IZADLR15A550 R5.5	8,50	DCMT 150404 US735	15,50
IZAPLC22A600 R6.0	14,00	IZADLR15A600 R6.0	8,50	DCMT 150408 UTI20T	11,90
IZAPLC22A700 R7.0	14,00	IZAPLR22A700 R7.0	15,00	DCMT 150408 US735	15,50
IZSPUC19A800 R8.0	22,00	IZAPLR22A800 R8.0	15,00		
IZSPUC19A900 R9.0	22,00	IZAPLR22A900 R9.0	15,00	DNMG 150604 HM NC3120	12,80
IZSPUC19AB100 R10.0	22,00	IZAPLR22AB100 R10.0	15,00	DNMG 150608 HM NC3120	12,80
IZSPUC19AB110 R11.0	24,00			DNMG 150612 HM NC3120	12,80
IZSPUC19AB120 R12.0	24,00	INSERTI convessi TIN			
IZSPUC19AB130 R13.0	24,00			€ EPGT 040102L W08 NS9530	17,50
IZSPUC19AB140 R14.0	24,00	IZADLR15AT10 R1.0	10,50	EPGT 040102R W08 NS9530	17,50
IZSPUC19AB150 R15.0	24,00	IZADLR15AT15 R1.5	10,50		
IZSPUC19AB160 R16.0	24,00	IZADLR15AT20 R2.0	10,50	GS110 U2 + TIN	16,00
IZSPUC31A170 R17.0	75,00	IZADLR15AT25 R2.5	10,50	GS130 U2 + TIN	16,00
IZSPUC31A180 R18.0	75,00	IZADLR15AT30 R3.0	10,50	GS160 U2 + TIN	16,00
IZSPUC31A190 R19.0	75,00	IZADLR15AT35 R3.5	10,50	GS185 U2 + TIN	16,00
IZSPUC31A200 R20.0	75,00	IZADLR15AT40 R4.0	10,50	GS215 U2 + TIN	16,00
		IZADLR15AT45 R4.5	10,50	GS265 U2 + TIN	16,00
		IZADLR15AT50 R5.0	10,50	GS315 U2 + TIN	16,00
		IZADLR15AT60 R6.0	10,50		
INSERTI concavi TIN	€	IZAPLR22AT70 R7.0	17,00	KNUX 160405 R11 NC3120	12,58
IZADLC15AT10 R1.0	11,50	IZAPLR22AT80 R8.0	17,00	KNUX 160410 R11 NC3120	12,58
IZADLC15AT15 R1.5	11,50	IZAPLR22AT90 R9.0	17,00	KNUX 160405 L11 NC3120	12,58
IZADLC15AT20 R2.0	11,50	IZAPLR22ABT10 R10.0	17,00	KNUX 160410 L11 NC3120	12,58
IZADLC15AT25 R2.5	11,50				
IZADLC15AT30 R3.0	11,50			€ NCMT 080204 R300	15,00
IZADLC15AT35 R3.5	11,50	ADKT 1505 PDSR MM NCM325	14,27	NCMT 090204 R300	15,00
IZADLC15AT40 R4.0	11,50	APKT 1035 PDSR MM NCM325	12,49	NCMT 110204 R300	15,00
IZADLC15AT45 R4.5	11,50	APKT 1035 PDFR MAB H01	11,19	NCMT 130304 R300	17,50
IZADLC15AT50 R5.0	11,50	APKT 1604 PDFR MA H01	11,63	NCMT 16T308 R300	18,00
IZADLC15AT55 R5.5	11,50	APKT 1604 PDSR MM NCM325	14,14	NCMT 220412 R300	20,00
IZAPLC22AT60 R6.0	16,00				
IZAPLC22AT70 R7.0	16,00	APKT 1003 PDR.10 SUP100	7,50	RCMT 0602 M0 61 T9125	9,30
IZSPUC19AT80 R8.0	24,00	APKT 1003 PDR.10 SUP200	7,50	RCMT 0803 M0 61 T9125	10,30
IZSPUC19AT90 R9.0	24,00	APKT 1003 PDR.10 SUP300	7,50	RCMX 1003 M0 61 T9125	7,72
IZSPUC19ABT10 R10.0	24,00	APKT 1604 PDR.17 SUP100	8,00	RCMX 10204 M0 61 T9125	10,31
IZSPUC19ABT11 R11.0	26,00	APKT 1604 PDR.17 SUP200	8,00		
IZSPUC19ABT12 R12.0	26,00	APKT 1604 PDR.17 SUP300	8,00	RDHW 0702 M0T PC3500	11,78
IZSPUC19ABT13 R13.0	26,00			RDHW 1003 NCM320K	11,49
IZSPUC19ABT14 R14.0	26,00	CCMT 060204 C25 NC3120	7,50		
IZSPUC19ABT15 R15.0	26,00	CCMT 060208 C25 NC3120	7,50	SCMT 09T304 C25 NC3120	8,63
IZSPUC19ABT16 R16.0	26,00	CCMT 09T304 C25 NC3120	8,32	SCMT 09T308 C25 NC3120	8,63
IZSPUC19ABT17 R17.0	80,00	CCMT 09T308 C25 NC3120	8,32	SCMT 120404 C25 NC3120	11,18
IZSPUC19ABT18 R18.0	80,00	CCMT 120404 HMP NC3120	10,92	SCMT 120408 C25 NC3120	11,18
IZSPUC19ABT20 R20.0	80,00	CCMT 120408 C25 NC3120	10,92		
				SEHT 1204 AFFN QH H01	12,81
		CNMG 120404 HM NC3120	9,84	SEHT 1204 AFSN X45 NCM325	12,97
		CNMG 120408 HM NC3120	9,84	SEKN 1203 AFSN NCM325	11,86
		CNMG 120412 HM NC3120	9,84		

	€		€		€
SEGN 120300 P30 SMUSSATRICE	8,40	TCMT 090204 C25 NC3120	6,86	VCMT 160404 HMP NC3120	13,28
SEGN 120300 T TIN SMUSSATRICE	9,40	TCMT 110204 C25 NC3120	7,24	VCMT 160408 HMP NC3120	13,28
SEGN 120300 A K10 SMUSSATRICE	9,40	TCMT 110208 C25 NC3120	7,24		
		TCMT 16T304 C25 NC3120	9,42	VNMG 160404 VF NC 3120	18,72
SNHX 1102T SRV	17,70	TCMT 16T308 C25 NC3120	9,42	VNMG 160408 VM NC3120	18,72
SNHX 1103T SRV	18,10				
SNHX 1203T SRV	19,00	TNMG 160404 HM NC3120	8,46	WCMT 020102 NX2525	18,86
SNHX 1205T SRV	20,40	TNMG 160408 HM NC3120	8,46		
		TNMG 220408 HM NC3120	11,88	WCMT 030208 C20 NCM325	12,28
SNMG 120404 HM NC3120	9,93	TNMG 220412 HM NC3120	11,88	WCMT 040208 C20 NCM325	12,28
SNMG 120408 HM NC3120	9,93			WCMT 050208 C20 NCM325	12,28
		TPGM 070102 L NS9530	14,50	WCMT 6T308 C20 NCM325	13,42
SPMR 090304 FNC3120	7,28	TPGM 070102 R NS9530	14,50	WCMT 080408 C20 NCM325	13,42
SPMR 090308 FNC3120	7,28				
SPMR 120304 FNC3120	9,64	TPGX 080202 L NX2525	14,80	WNMG 060404 HM NC3120	9,07
SPMR 120308 FNC3120	9,64	TPGX 080204 L NX2525	14,80	WNMG 060408 HM NC3120	9,07
				WNMG 080404 HM NC3120	11,44
SPMT 070308 ACP300	8,00	TPMR 110304F NC3120	6,95	WNMG 080408 HM NC3120	11,44
SPMT 09T308 ACP300	9,90	TPMR 110308M NC3120	6,95	WNMG 080412 HM NC3120	11,44
SPMT 120408 ACP	13,10	TPMR 160304F NC3120	8,46		
		TPMR 160308F NC3120	8,46	YSS1155 HSS+TIN Da 9 a 12	67,00
TBGT 060102 LW T1500A	11,00			YSS1155 HSS+TIN Da 13 a 17	72,00
TBGT 060104 LW T1500A	11,00	VBMT 160404 HMP NC3120	13,28	YSS1155 HSS+TIN Da 18 a 24	80,00
		VBMT 160408 HMP NC3120	13,28	YSS1155 HSS+TIN Da 25 a 35	95,00
TCMT 080204 NX3035	7,00			YSS1155 HSS+TIN Da 36 a 47	120,00
		VCMT 110304 VF NC3225	11,80	YSS1155 MSS+TIN Da 48 a 65	150,00

## EXPORT TOOLS s.r.l.

Via del Lavoro 8/N15  
 Quarto Inferiore  
 40057 Granarolo dell'Emilia - BO  
 Tel. 051 768632 Fax. 051 6058830  
 e-mail: info@export-tools.com  
 www.export-tools.com